

Type	: Rechargeable Nickel Cadmium Cylindrical Cell
Nominal Dimension (with Sleeve)	: $\phi=14.5\text{mm}$ H = 48.0mm
Discharge Rate	: Recommended Max discharge current 2400mA
Nominal Voltage	: 1.2V
Capacity	: Minimum: 800mAh Typical: 840mAh When discharged at 160mA to 1.0V at 20
Standard Charge	: 80mA for 16hrs at 20
Fast Charge	: 400mA to 800mA (0.5C to 1C) Charge termination control recommended Control parameters: - V : 5 ~ 10mV DT/dt : 0.8 ~ 1 /min TCO : 45 ~ 50 Timer : 105% nominal input
Service Life	: > 500 cycles (IEC standard)
Continuous Overcharge	: 80mA maximum current for 28 days No conspicuous deformation and/or leakage
Weight (approximate)	: 23.0g
Internal Resistance	: 25m upon fully charged at 1000Hz
Charge Retention	: 70% (IEC standard)
Ambient Temperature Range (Recommended)	: Standard Charging : 0 to 45 Fast Charging : 10 to 35 Discharging : - 20 to 60 Storage : - 20 to 35

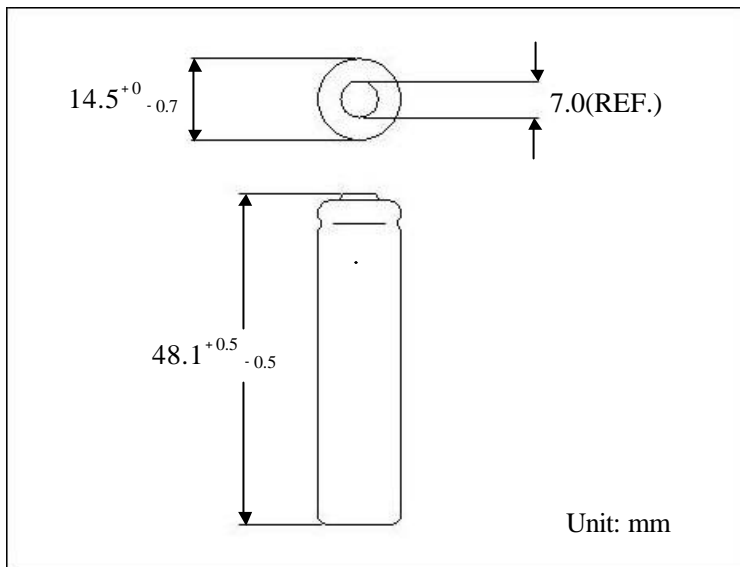

**Charge**

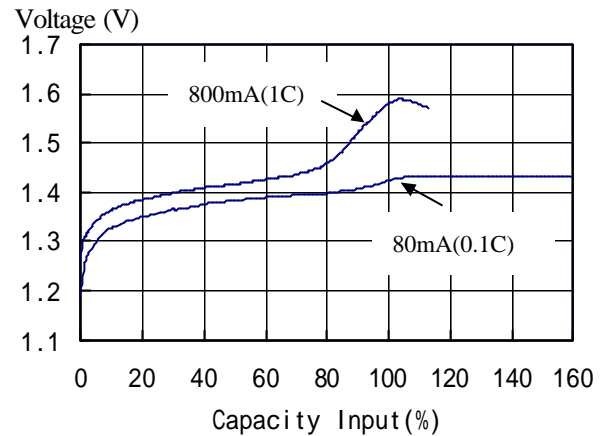

**Low Rate Discharge**

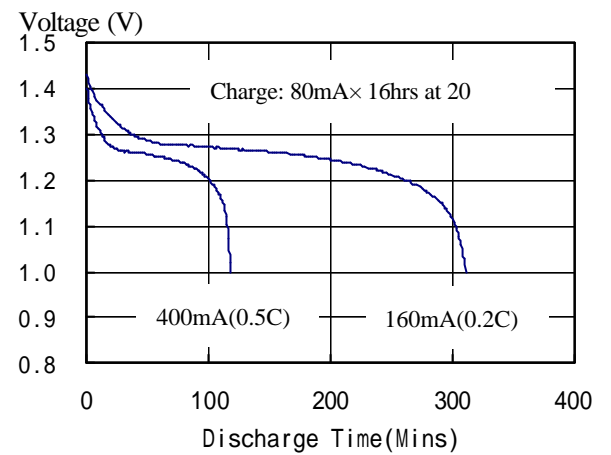

**High Rate Discharge**

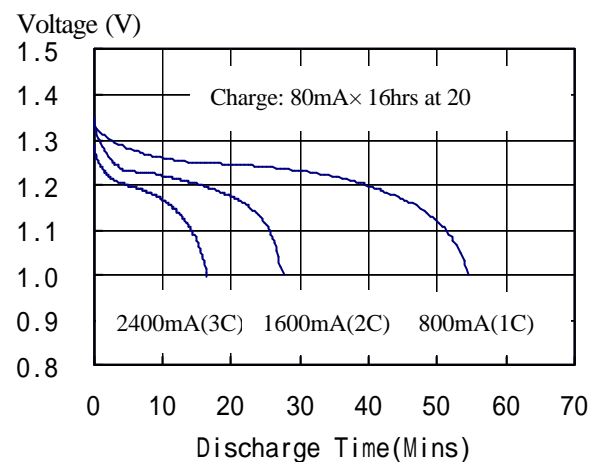

\* The information contained in this document is for reference only and should not be used as a basis for product guarantee or warranty. For applications other than those described here, please consult C-POWER.

Note: All the above values subject to change without prior notice.